



AUTOMATIC PILL DISPENSER

User Guide

This user guide is intended to provide you with guidelines to ensure that operation of this product is safe and does not pose risk to the user. Any use that does not conform to the guidelines described in this User Guide may void the limited warranty.

Please read all directions before using the product and retain this guide for reference.

This product is intended for household use only. It is not intended for commercial use.

Safety Tips and Precautions

- Do not let children use or play with this device.
- Do not use any attachments not supplied or recommended by the manufacturer.
- Do not place the appliance near open flames or heat sources. Fire, electric shock, product damage, or injury might occur.
- Make sure to keep the pill dispenser on a flat, stable surface. Do not flip it upside down unless you are removing pills from their compartment. Please note, the internal pill container is removable for easy filling.
- Be careful not to drop the pill dispenser, as this could damage the product or the pills inside.
- Water can damage the dispenser, cause issues with the batteries, or otherwise adversely affect the medication contained inside. Do not immerse this pill dispenser in water or other liquids, or expose it to liquids that might get splashed on it. Do not place it in an environment where there is excessive moisture or humidity.
- Do not fill the internal pill container unless it is completely dry.
- Never force the locking cover open.
- Never use mismatched batteries, or batteries with wrappings that have been torn or damaged in any way.
- Do not mix old and new batteries.
- Organizing medications correctly and assigning quantities and times is the sole responsibility of the user and/or their caregiver or healthcare provider.

- If you do miss a dose for any reason, please contact your healthcare provider and/or follow the directions provided by your physician or pharmacist.
- Some medications should be stored tightly sealed and not exposed to the air. If you are uncertain about whether this dispenser is appropriate for storing your medications, please check with your healthcare provider or pharmacist.
- A low battery symbol  will appear in the upper right corner of the LCD display when battery power is low. Be sure to change the batteries promptly to ensure the proper operation of the pill dispenser.

Package Contents

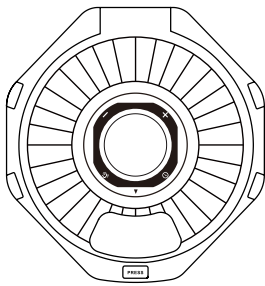

Automatic
Pill Dispenser

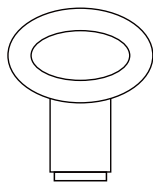

Locking key

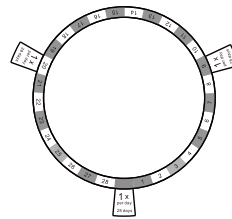

Dosage rings (9)

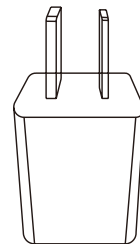

Power Adapter

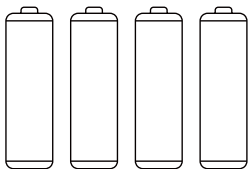

AA alkaline
batteries (4)



User guide

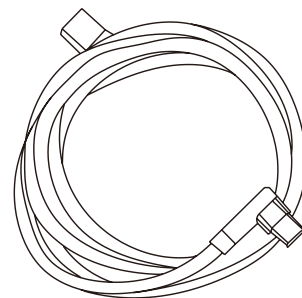

Charging Cable

Product Overview

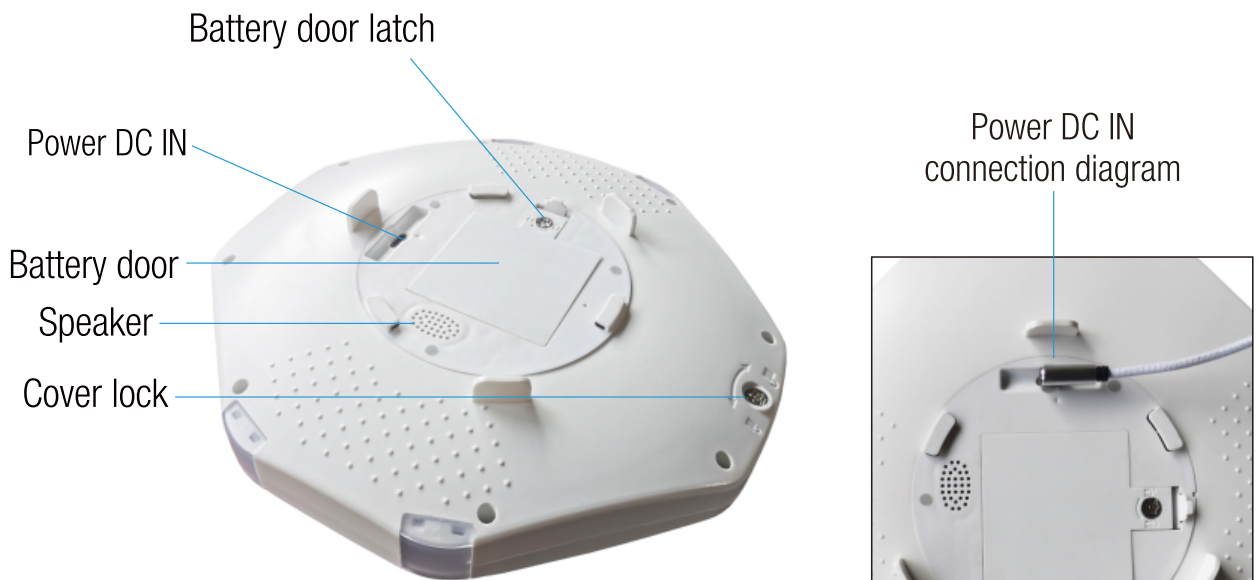

Understanding the Daily Dosage Rings

Your Automatic Pill Dispenser comes with 9 different rings, corresponding to the number of times per day that medication needs to be dispensed. The rings are designed to help you in laying out medication in the internal pill container so it is properly dispensed. The internal pill compartment has 28 slots for medication.

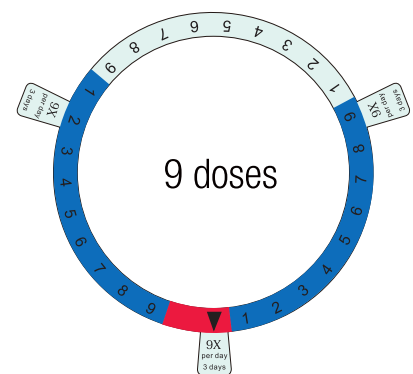
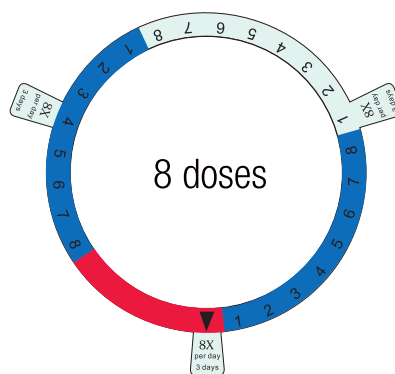
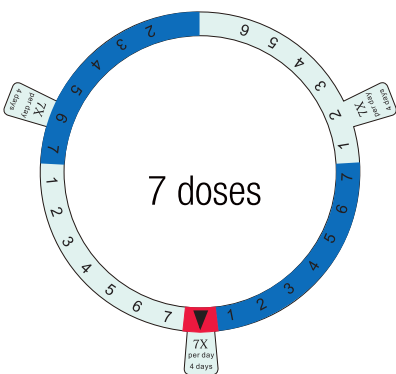
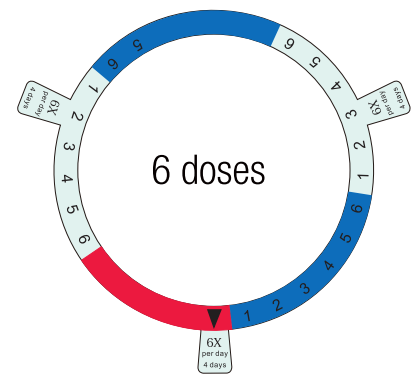
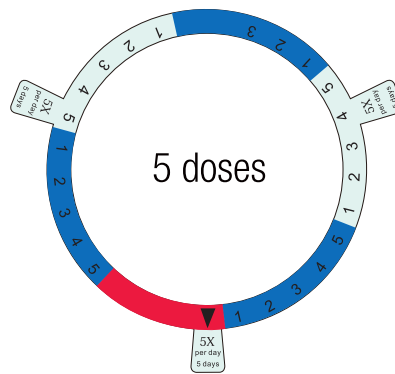
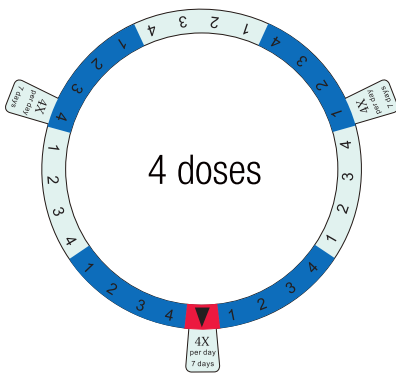
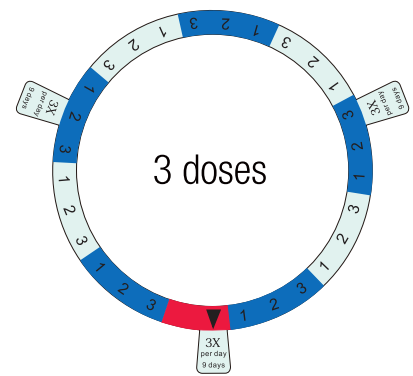
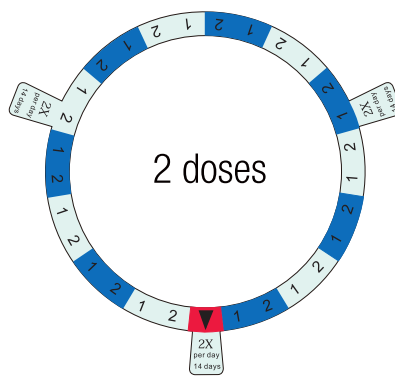
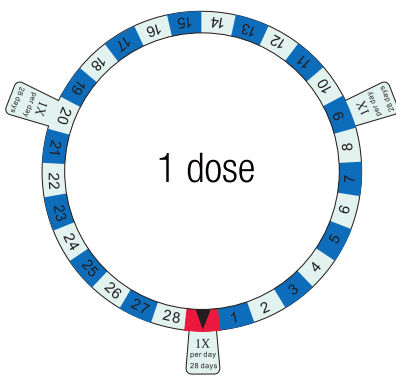

The dosage ring must first be placed in the center of the internal pill container with the tab in the bottom spot (indicated by the ▼ on the plastic container.) Align the two triangles marks on the dosage ring and faceplate, then fold tabs down to secure dosage ring in place before you start filling dispenser with medication.

Once the dosage ring is properly situated, the alternating colors help you to distinguish between days. For example, if you are using the 2x Per Day ring (meaning medication only needs to be dispensed at two different times each day), this will accommodate 14 days worth of medication.

The green numbers to the right of the tab are the first days medications. The white spaces are the following days medications. The colors alternate so that days do not get confused. The space marked 1 is where you would put the first dose for that day, the space marked 2 is where you would put all medications to be dispensed at the second time, etc. The pill compartments should accommodate all necessary medications in a single slot.

DO NOT PUT MEDICATION IN THE SLOTS INDICATED BY THE RED

SPACES. These spaces indicate remainder times. For example, if you need medication dispensed at 5 different times during the day, the ring can accommodate 5 days, or 25 medication

times. Three slots are left over. These leftover slots are indicated by the red ring, and this is why there are substantially larger red areas on the 5x per day and 6x per day rings. Do not put medication in those slots.

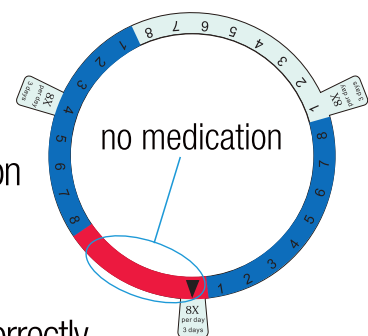

To use the Daily Dosage Rings, choose the ring with the tab that correctly indicates how many times per day you need medication dispensed. Position the ring around the compartment. Fill each compartment accordingly and then place the carousel back into the dispenser with the dosage ring.

Ring #	# of Meds per Day	Programmable Time Period
1	1	28 days
2	2	14 days
3	3	9 days
4	4	7 days
5	5	5 days
6	6	4 days
7	7	4 days
8	8	3 days
9	9	3 days

Installing the Batteries

1. Turn the dispenser upside-down. Use the locking key by inserting it into the battery cover and turning clockwise.
2. Remove the battery door.
3. Insert four (4) AA alkaline batteries, making sure to match the polarities (+ and - sides) with the + and - markings inside the compartment.
4. Replace the battery cover and insert the key into the cover. Then, turn the key counterclockwise to lock the cover.

NOTE: If the low battery symbol appears on screen, then the batteries need to be replaced.

****The power of device is by external DC5V. The 4xAA alkaline batteries are only used to backup power while the external DC5V is removed.**

Locking and Unlocking the Cover

The cover lock helps to prevent accidental spills and prevents unwanted access to your medication dispenser. This can also help with patients who are confused and may try to take medication at the wrong times.

1. Take the locking key and line it up with the hole on the cover lock (located on the bottom of the dispenser as shown.)
2. Press down on the cover latch and turn the key clockwise to lock the cover.
3. Turn the key counterclockwise to unlock the cover.
4. Lift the cover open using the cover latch.

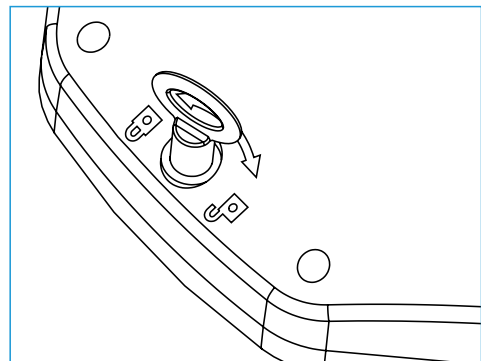

Selecting the 12-Hour/24-Hour Mode

- Press and hold the CLOCK button for two (2) seconds to switch between 12 and 24 hour mode.



Setting the Time

1. Press the CLOCK button once to start the time setting.
2. Press the + or - button to adjust the hour. Then, press the CLOCK button once move to adjust the minute.

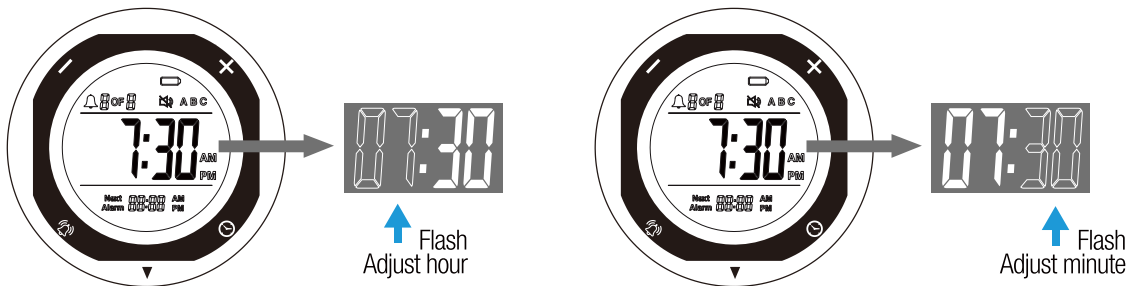

3. Use the + or - button to adjust the minute, similar to the hour.
NOTE: Press and holding the + or - button will cause the hour or minute digits to move faster.
4. Press the CLOCK button to exit time setting with changes saved. Or press and hold the CLOCK button for two (2) seconds to cancel setting change and exit out of the time setting.
NOTE: The digits on display will flash to indicate which digits is currently being changed.

Setting the Alarm

1. Press the "ALARM" button to start the alarm time setup.
2. Press the "+" or "-" to select between an alarm, then press the "ALARM" to confirm.
3. Press the "+" or "-" to adjust the hour. Then, press the "ALARM" button to confirm the hour and set the minute.
4. Press the "+" or "-" button to adjust the minute, similar to the hour.

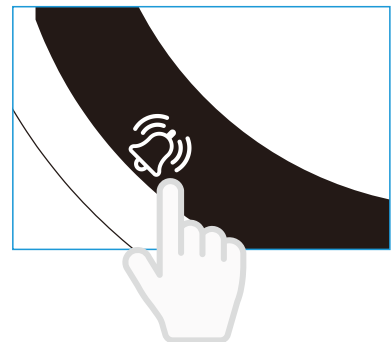

NOTE: Press and holding the + or - button will cause the hour or minute digits to move faster. And the digits on display will flash to indicate which digits is currently being changed.

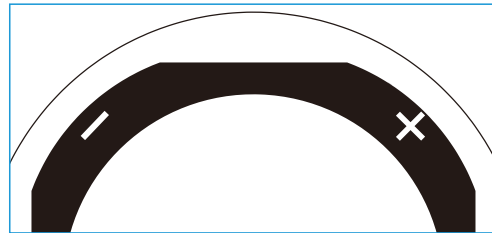

5. Press the "ALARM" button once or press and hold down the "ALARM" button for two(2) seconds to save desired alarm settings and exit out of alarm setting mode. To cancel setting changes, simply wait a few seconds for alarm setting mode to end automatically.

To delete current alarm settings, press and hold the CLOCK button while in alarm setting mode until **..!..** is shown on the display screen.

★ **Flashing red light means overtime alarm. (Medications are taken late.)**

Setting the Alarm Tone and Volume

- Press and hold the Alarms button for three (3) seconds to select between different alarm tones. The alarm tone is represented by A, B or C which is displayed on-screen.
- Press and hold the "-" button for three (3) seconds to select between different volume levels. The volume level is represented by the Speaker symbol which is displayed on-screen

The three alarm tones have distinct beeping patterns:

- o **Alarm A:** A continuous beep that goes on for 20 seconds. After that, the beep will stop for 10 seconds, then it will resume to beep and continue in that cycle.
- o **Alarm B:** There are three(3) sets of beeps and three(3) beeps for each set. The beep will stop for 7 seconds, then it will resume to beep and continue in that cycle.
- o **Alarm C:** There is one (1) beep every three (3) seconds.

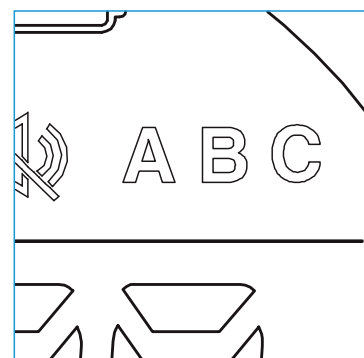

WiFi Connection Setup

1. Download and install APP

Download and install the APP on your or your caregiver's smartphone via as following ways:

- Scan QR code to download iDispenser APP.
- Search for "iDispenser" via "Google Play". 
- Search for "iDispenser" via the apple APP Store. 

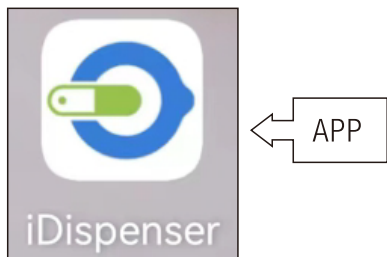

2. Register

If you are a first time iDispenser user, please create an account.

- Open the iDispenser & tap "Register."
- Agree to the Privacy Policy terms & conditions.
- Enter a valid email address or phone number verify.
- Get verification code & enter verification code.
- Create a password and login.

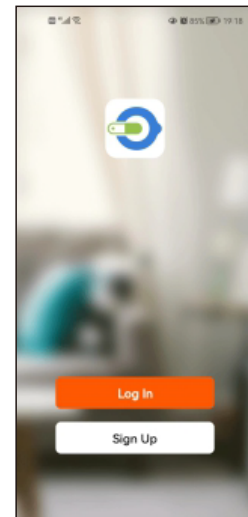

3. Wi-Fi setup for Device and connection

- In the home page clock mode , press and hold the + button for three(3) seconds to enter Wi-Fi AP mode, Simultaneously, The speaker play a voice of AP Mode and the LEDs flash. If there are no operation for 3 minutes, the device will exit the AP mode automatically and return the home page clock mode. Press and hold the + button for three(3) seconds again will exit AP mode.

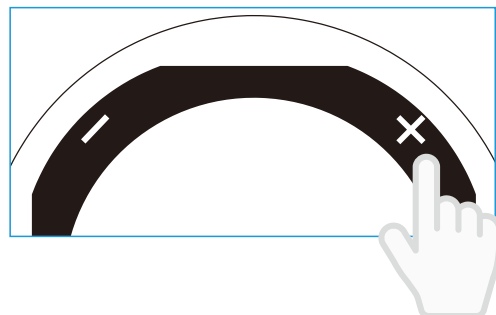

- Open the APP of iDispenser in smart phone, and then click the "+" button to enter Add device page , select Others--->Others(Wi-Fi).

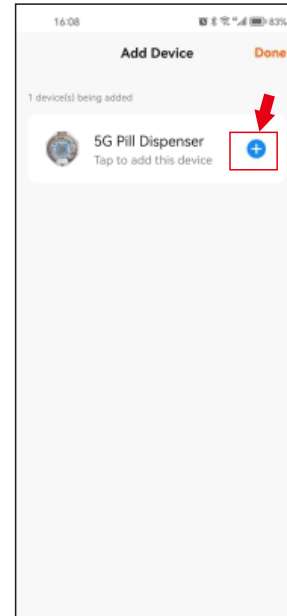
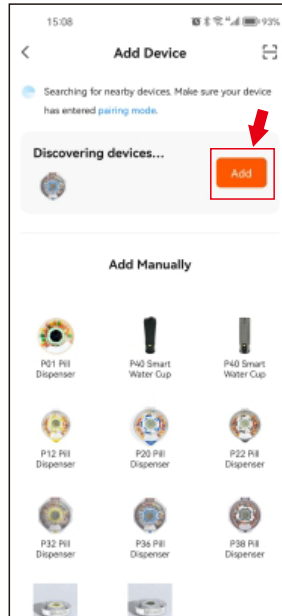
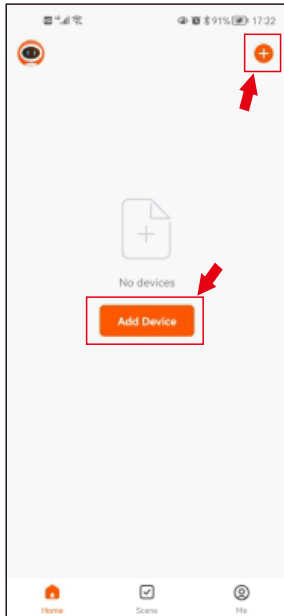

- Input the Password which is the same of Wi-Fi password in smart phone, and then click "next" .

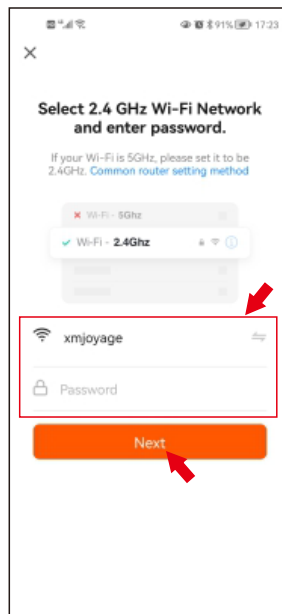

- Wi-Fi connection successfully, the  is shown on the display screen. If Wi-Fi connection failed please check as follow ways:

- 1> Is the SSID and password of Wi-Fi correct?
- 2> If your Wi-Fi is not 5GHz, please set it to be 2.4GHz.
- 3> Reset the device, press and hold + button to enter AP mode again. Re-connect Wi-Fi.

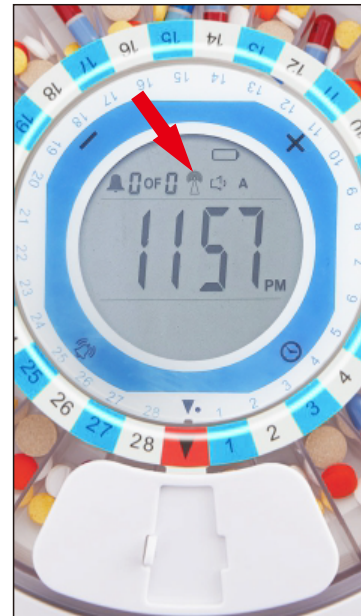
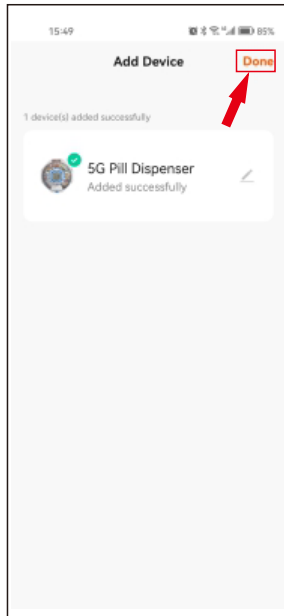
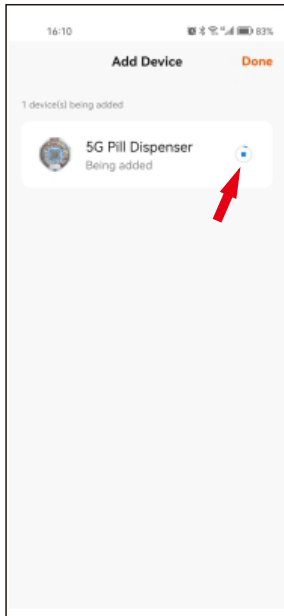

- Remove Device

*In home page, Press and hold "Device" icon for two(2) seconds to enter "Device Selected" page, and then select one or more devices which you want to remove, click "remove device" icon, and click "Done" to return home page.

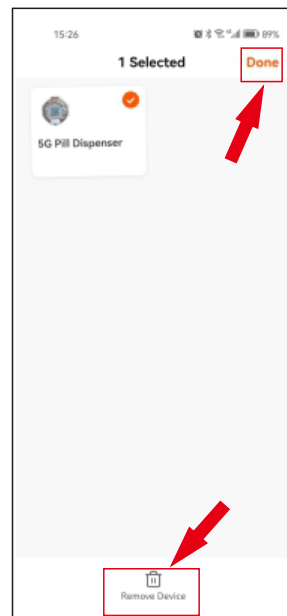
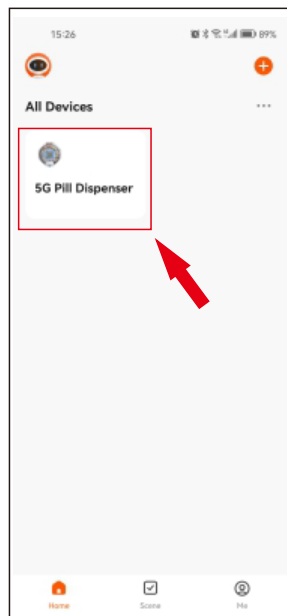

- **APP Notifications**

In home page, select "Me"----> Settings ----> APP notification.

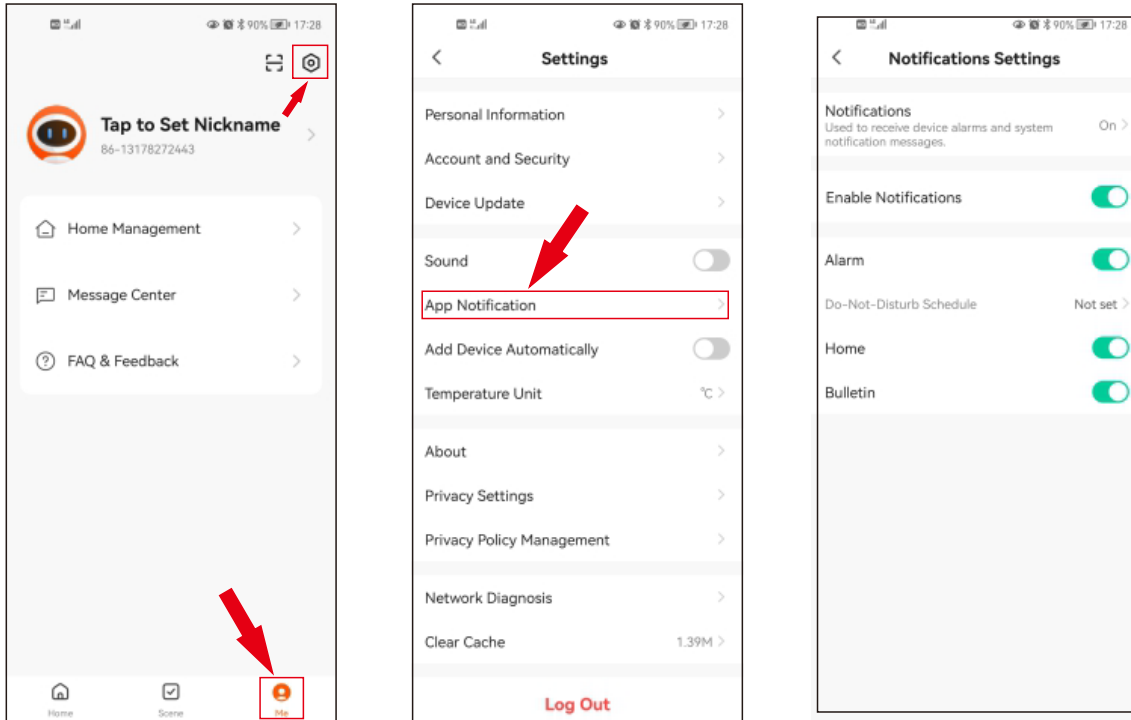

Reset All Settings

- Press and hold the CLOCK and ALARM buttons simultaneously for five (5) seconds to clear and reset all settings.

Activate the Factory Test Mode

- Press and hold the + and - buttons simultaneously for five (5) seconds to enter Factory Test Mode. To quit Factory Test Mode, press and hold the CLOCK button for three (3) seconds.

Operating the Pill Dispenser

1. Choose the Daily Dosage Ring that corresponds to your needs (please refer to Understanding the Daily Dosage Rings on page 5).
2. Situate the Daily Dosage Ring in the center of the internal pill container and place your medications in the container to correspond with when they are taken (1st, 2nd, 3rd, etc.) indicated by the numbers on the ring (1, 2, 3, etc.). Do not place any medication in the red sections. When you see the red approaching the dosage window, it is time to refill the container.
3. Install the batteries (please refer to Installing the Batteries on page 7).
4. Unlock the cover using the key (please refer to Locking and Unlocking the Cover on page 7) and place the internal pill container inside the main body.
5. Set the time (please refer to Setting the Time on page 8).
6. Adjust the alarm volume, alarm tones, and choose 12- or 24-hour time (please refer to Setting the Alarm Volume and Selecting the 12-Hour/24-Hour Mode).
7. Set your medication times (please refer to Setting the Alarm on page [insert page]).
8. Close the cover and lock it with the provided key (please refer to Locking and Unlocking the Cover on page 7).
9. At the designated medication times, the alert will sound.
10. Slide open the window by pushing the tab to the right.
11. Tilt up the pill dispenser to pour the pills out into your hand or medication cup. Check to make sure all pills have come out of the compartment. The alarm should stop automatically.
12. Close the dispensing window and place the pill dispenser on a flat surface.

Care and Maintenance

- Wipe the exterior with a soft, damp cloth. Do not use harsh detergents.
- If needed, remove the internal pill container and gently rinse/wipe the individual pill compartments. Allow the container to dry fully before replacing it or refilling it.
- Do not immerse the outer pill dispenser in water or any other liquid.
- Make sure that the internal pill container is clean and dry before refilling it.